

Uni-Hydro™ Ironworkers

Model	Punch	Die
All Models	UHP	UHD

Note: Uni-Hydro™ Ironworkers use Punch Style UHP2 or 237 and Die Style UHD2, 422 or 490 for Oversize Hole Punching.

PUNCHES

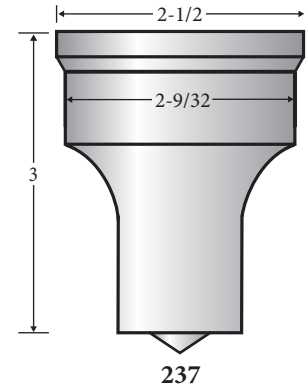
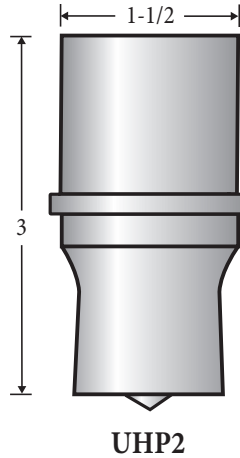
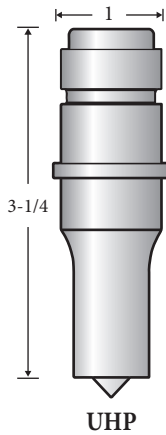

DIES

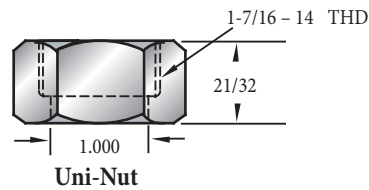
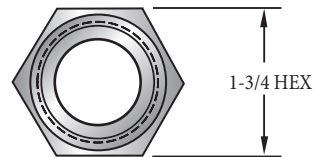
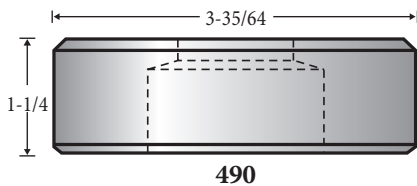
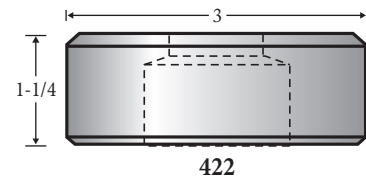
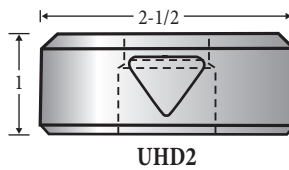
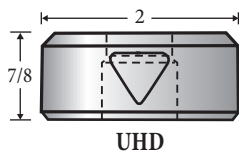

SHEAR BLADES

We manufacture Shear Blades for all types of Ironworkers and can custom manufacture to your specifications.

